

# SUBMERSIBLE TURBINE PUMPS

6" STS SERIES - 150 GPM

**FPS**

## FEATURES

- 100% factory wet tested with test results shipped with each pump
- Premium ductile iron casting for longer life and higher pressures
- Longer discharge and motor bracket bearings for increased pump life
- Spiral cutlass rubber intermediate bearings designed for harsh environments
- 416 Stainless steel pump shaft ground and polished for maximum durability
- Investment cast stainless steel impellers for superior performance
- Custom configurations available
- The optional bracket provides the ability to use larger 8" motors on smaller 5" and 6" pumps, offering higher performance ratings and system optimization

## SPECIFICATIONS

- 6" minimum well I.D.
- 10' minimum submergence above inlet
- 4" NPT discharge
- 350 psi standard (675 psi double bolted) maximum working pressure
- 150 ppm maximum allowable amount of sand
- Basic Model: 150STS6, PEI<sub>CL</sub> Number: 0.90

## MODEL NO. EXPLANATION

- Example: 175STS10D6X-0464
- 175 = GPM
- STS = Sub Turbine Series
- 10 = Motor HP
- D = Ductile Iron
- 6 = 6" Pump
- X = Impeller Trim Configuration
- 04 = Number of Stages
- 6 = 6" Motor Bracket
- 4 = 4" Discharge

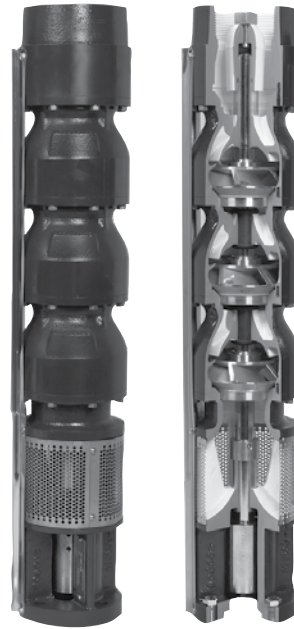

# SUBMERSIBLE TURBINE PUMPS

6" STS SERIES - 150 GPM



## PERFORMANCE

Basic Model	PEI <sub>CL</sub> Number
150STS6	0.90

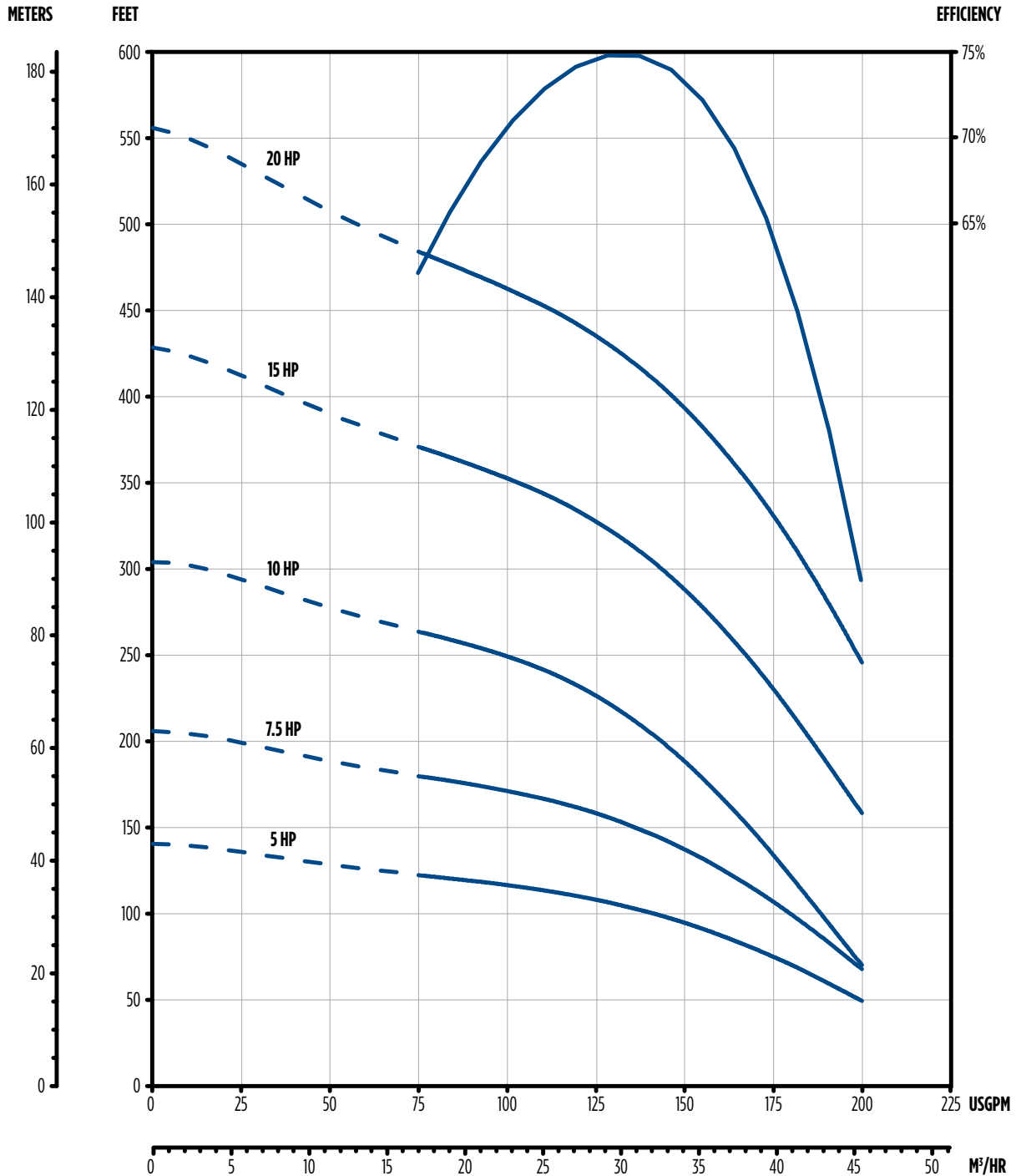

— RECOMMENDED OPERATING RANGE

NOTE: Performance based on 68 °F fresh water; 6" motor at 3450 rpm

# SUBMERSIBLE TURBINE PUMPS

6" STS SERIES - 150 GPM



## PERFORMANCE

Basic Model	PEI <sub>CL</sub> Number
150STS6	0.90

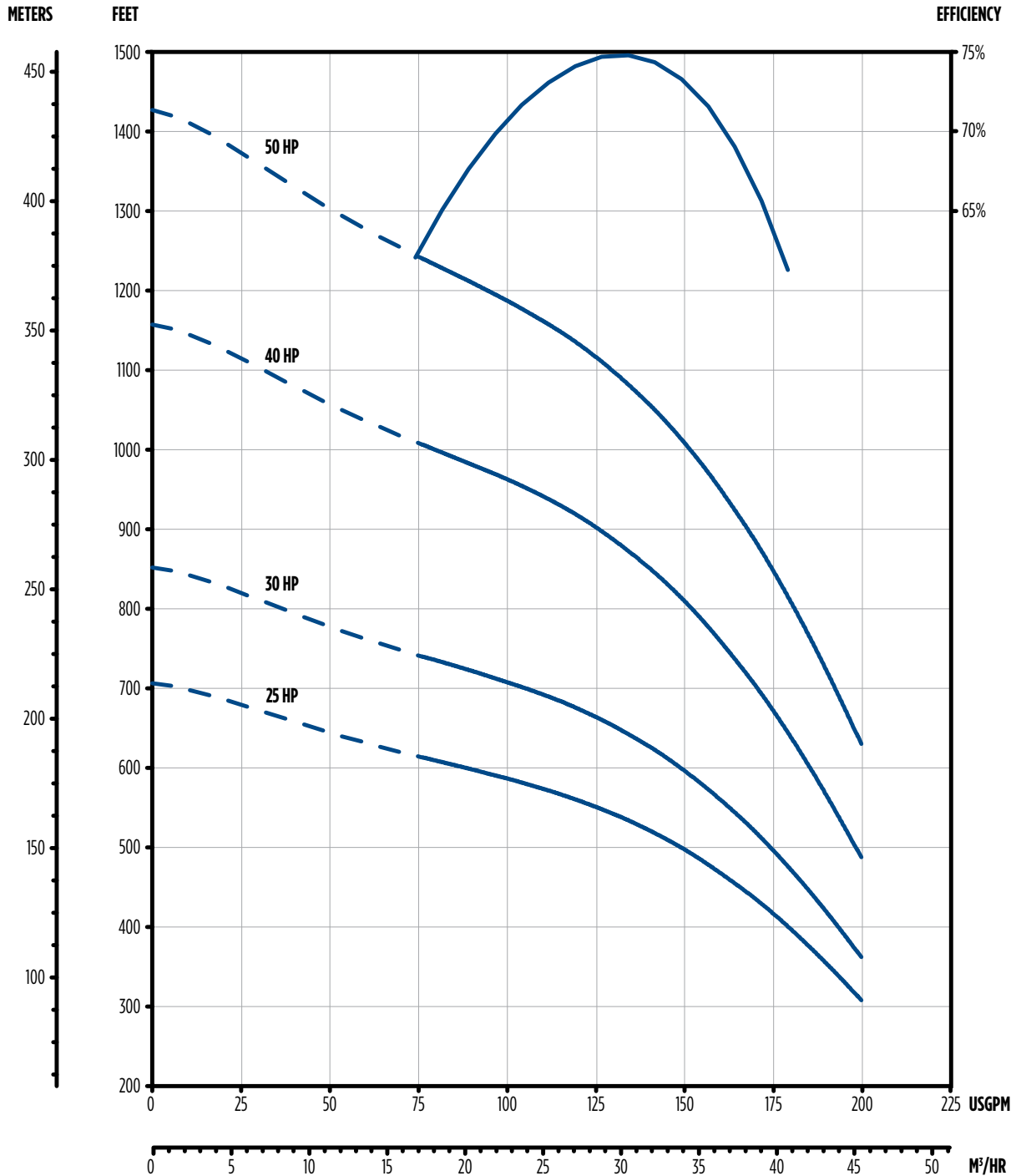

— RECOMMENDED OPERATING RANGE

NOTE: Performance based on 68 °F fresh water; 6" motor at 3450 rpm

# SUBMERSIBLE TURBINE PUMPS

6" STS SERIES - 150 GPM



## DIMENSIONS

SINGLE-STAGE

Basic Model	PEI <sub>CL</sub> Number
150STS6	0.90

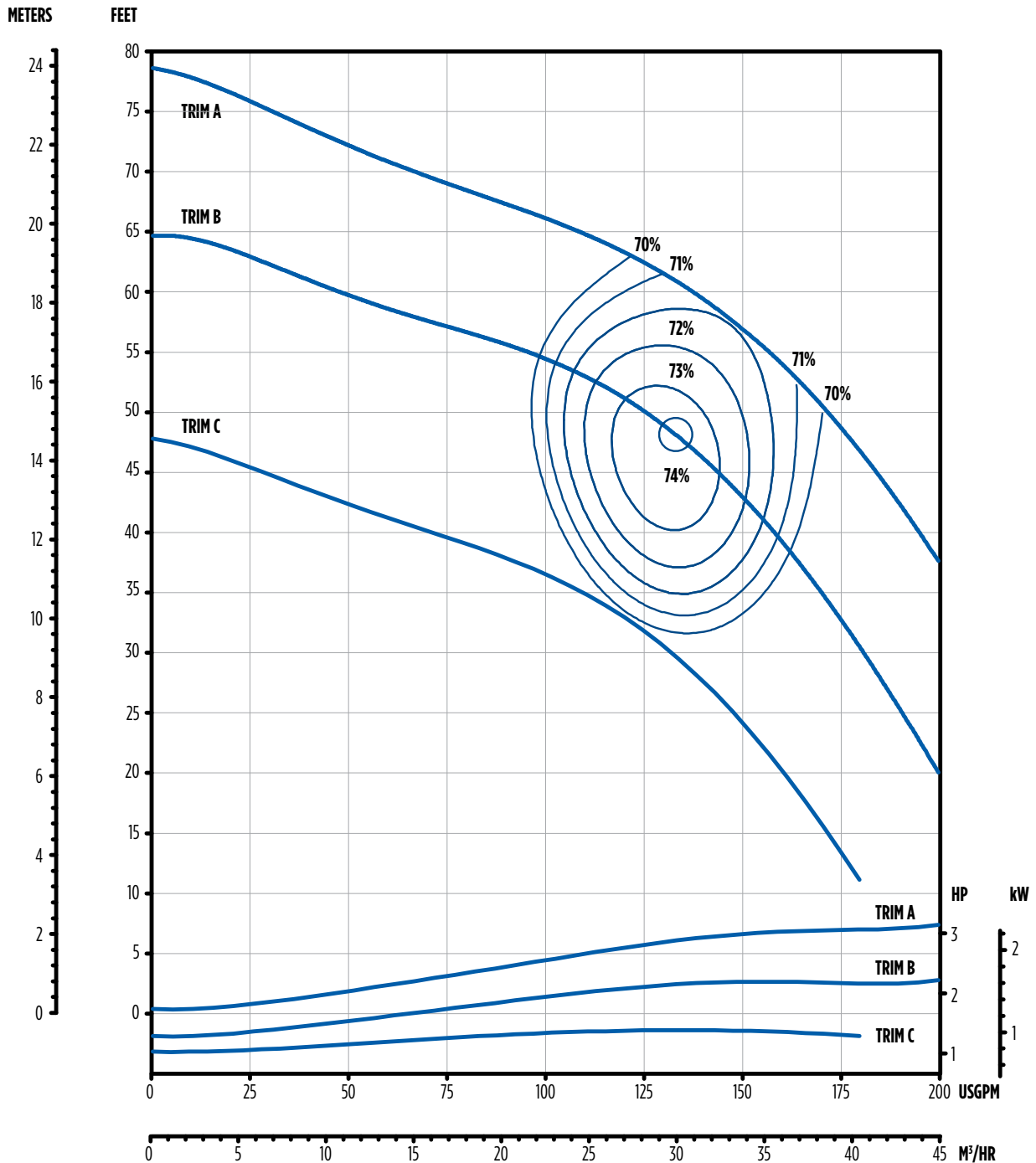

Note: Efficiencies are typical, not guaranteed; efficiency correction required for low stage count (1 stage-6%, 2 stage-2%, 3 stage-1%); pumps are intentionally designed to utilize some portion of the motor's 1.15 service factor; bowl #9 begins transition to double bolted (8 bolts at bottom, 14 bolts at top); nominal rpm is 3450

# SUBMERSIBLE TURBINE PUMPS

6" STS SERIES - 150 GPM



## ORDERING INFORMATION

HP	Stages	Trim Size	Motor Size	Discharge Size	Basic Model	PEI <sub>CL</sub>	Order No.	Model No.	Shipping Wt. (lbs)
5	2	1A, 1B	6"	4" NPT	150STS6	0.90	97060150302	150STS5D6X-0264	76
7.5	3	1A, 2B					97060150303	150STS7D6X-0364	90
10	5	4B, 1C					97060150105	150STS10D6X-0564	117
15	6	4A, 1B, 1C					97060150306	150STS15D6X-0664	129
20	7	A					97060150007	150STS20D6A-0764	143
25	9	A					97060150009	150STS25D6A-0964	196
30	11	10A, 1B					97060150311	150STS30D6X-1164	220
40	15	14A, 1B					97060150315	150STS40D6X-1564	288
50	18	A					97060150018	150STS50D6A-1864	331

## DIMENSIONS

HP	Stages	Trim	Motor Size	P	M*	MD*	Motor Wt. lbs	Pump Wt. lbs
				in	in	in		
5	3	B	6"	25.46	22.90	5.38	101	64
7.5	5	4B, 1C		30.21	24.20	5.38	108	76
10	6	1A, 5B		39.71	25.40	5.38	116	101
15	10	B		44.46	28.00	5.38	129	113
20	10	9A, 1B		49.21	30.60	5.38	135	125
25	9	A		58.71	33.10	5.38	148	150
30	11	10A, 1B		68.21	35.70	5.38	162	174
40	15	14A, 1B		87.21	40.80	5.38	195	223
50	18	A		101.46	57.80	5.38	310	260

NOTE: \*MD diameter = Franklin Electric Motor, M = Maximum Length of Franklin Electric Motor

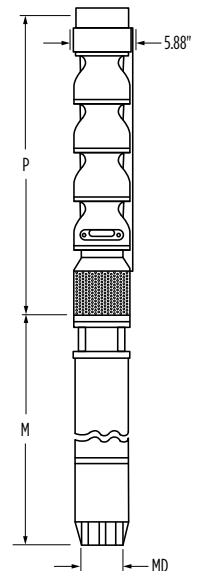

## DIMENSIONS

### IMPELLER

Trim	Diameter (in)	C Angle
A	4.688"	27°
B	4.250"	27°
C	3.750"	27°

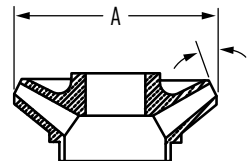

## MATERIALS

Part Name	Common Material Name	Material Specification No.
Discharge Bracket	Ductile Iron	ASTM A536 65-45-12
Top Bowl	Ductile Iron	ASTM A536 65-45-12
Intermediate Bowl	Ductile Iron	ASTM A536 65-45-12
Bearings, Discharge/Suction	Bronze	ASTM B584 C89835
Impeller	304 Stainless Steel	ASTM A743/A743M CF8
Pump Shaft	416 Stainless Steel	ASTM A582 S41600
Suction Bracket	Ductile Iron	ASTM A536 65-45-12
Bowl Bearing	Rubber	Rubber
Sand Collar	300 Stainless Steel	ASTM A666
Suction Screen	302 Stainless Steel	ASTM A240 S30200
Cable Guard	300 Stainless Steel	ASTM A666
Shaft Coupling	416 Stainless Steel	ASTM A582 S41600
Upthrust Bolt	300 Stainless Steel	ASTM A666
Taper Lock	416 Stainless Steel	ASTM A582 S41600
Bolting	300 Stainless Steel	ASTM A666

NOTE: Bowl bearing and shaft options available; contact customer service for available options

# SUBMERSIBLE TURBINE PUMPS

6" STS SERIES - 150 GPM



## REPAIR PARTS

Item No.	Part Description	Part No.	Qty. Per
1,2	Upthrust Bolt/Nut Kit	305471553	1
3	Discharge 4" NPT (no top bearing)	305471449	1
	Discharge 4" NPT w/Rubber Top Bearing	305471453	
	Discharge 4" NPT w/FKM Top Bearing	305471455	
4	Top Bearing, Bronze-150 gpm (included in 5)	305471385	As Req.
	Top Bearing, Rubber (included in 3)	305471395	
	Top Bearing, FKM (included in 3)	305471396	
5	Top Bowl w/Bronze Top Bearing	305471519	As Req.
	Top Bowl w/Bronze Top Bearing XP	305471520	
6	Bowl Bolt Kit (8 pieces)*	305471548	As Req.
	Bowl Bolt Kit (1000 pieces)	305471550	
7	Bowl Bearing, Bronze-150 gpm (included in 8)	305471387	As Req.
	Bowl Bearing, Rubber-150 gpm (Included in 8)	305471398	
	Bowl Bearing, FKM-100 GPM (included in 8)	305471399	
8	Bowl and Bearing Assembly, Bronze	305471487	As Req.
	Bowl and Bearing Assembly XP, Bronze	305471491	
	Bowl and Bearing Assembly, Rubber	305471485	
	Bowl and Bearing Assembly XP, Rubber	305471489	
	Bowl and Bearing Assembly, FKM	305471488	
	Bowl and Bearing Assembly XP, FKM	305471492	
9	Taper Lock Collet Kit (included in 10)	305471372	As Req.
12	Sand Cap w/Set Screws	305471374	1
13	Motor Bracket Bearing, Bronze (included in 14)	305471389	As Req.
	Motor Bracket Bearing, Rubber (included in 14)	305471395	
	Motor Bracket Bearing, FKM (included in 14)	305471396	
14	6" Motor Bracket w/Bronze Bearing	305471419	1
	6" Motor Bracket w/Rubber Bearing	305471420	
	6" Motor Bracket w/FKM Bearing	305471422	
	8" Motor Bracket w/Bronze Bearing**	305472598	
15	6" Suction Screen w/Screws	305471377	1
17	Cable Guard Screw Kit (8 pieces)	305471000	1
18	6" Coupling	305471402	1
-	6" Motor Bolt Kit	305352901	1
19	Nameplate w/Drive Screws	305418901	1
-	Owner's Manual	106089101	1

\*Pumps of 9 stages or more require double bolting; two bolt kits (305471548) per stage will be required for the 9th stage and above

\*\*8" Motor rated up to 60 hp

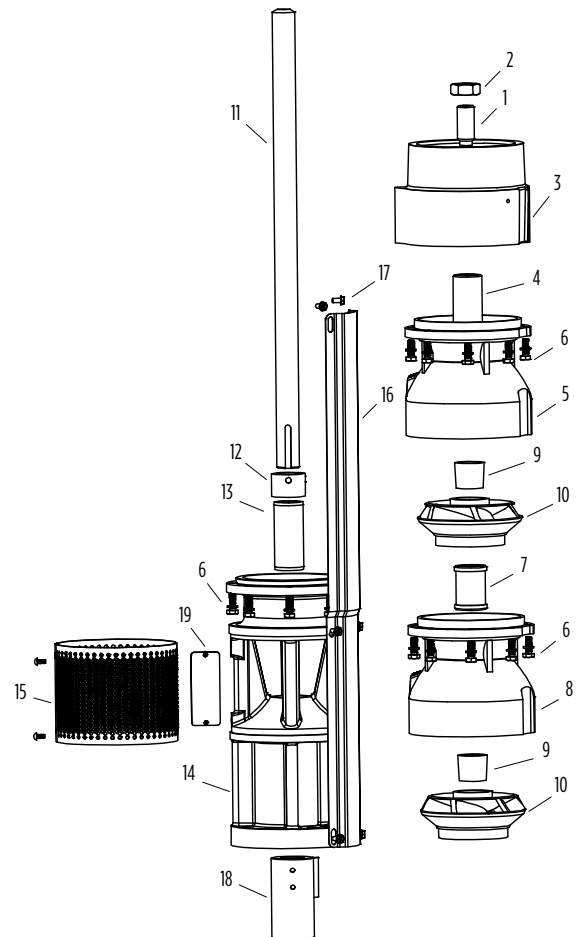

## REPAIR PARTS

## IMPELLER

Item No.	Trim	Diameter (in)	C Angle	Kit w/Collets
10	A	4.688"	27°	305471557
	B	4.250"	27°	305471558
	C	3.750"	27°	305471559

NOTE: Shaft and cable guard information located on the following pages

# SUBMERSIBLE TURBINE PUMPS

6" STS SERIES - 150 GPM



## REPAIR PARTS

6" Shafts				
Item No.	Stages	Length	Part No.	
			416 SS	Chrome
11	1	15.56	305471302	305471345
	2	20.31	305471303	305471346
	3	25.06	305471304	305471347
	4	29.81	305471305	305471348
	5	34.56	305471306	305471349
	6	39.31	305471307	305471350
	7	44.06	305471308	305471351
	8	48.81	305471309	305471352
	9	53.56	305471310	305471353
	10	58.31	305471311	305471354
	11	63.06	305471312	305471355
	12	67.81	305471313	305471356
	13	72.56	305471314	305471357
	14	77.31	305471295	305471338
	15	82.06	305471315	305471358
	16	86.61	305471316	305471359
	17	91.56	305471317	305471360
	18	96.31	305471318	305471361
	19	101.06	305471319	305471362
		Cut-To-Length	4	305471363
	Cut-To-Length	6	305471364	-
	Cut-To-Length	8	305471365	-
	Cut-To-Length	10	305471366	-

6" Cable Guards (Pre-Cut)			
Item No.	Stages	Length (in)	Part No.
16	Cut-To-Length	120.00	305471100
	1	18.62	305471121
	2	23.38	305471122
	3	28.12	305471123
	4	32.88	305471124
	5	37.62	305471125
	6	42.38	305471126
	7	47.12	305471127
	8	51.88	305471128
	9	56.62	305471129
	10	61.38	305471130
	11	66.12	305471131
	12	70.88	305471132
	13	75.62	305471133
	14	80.38	305471119
	15	85.12	305471134
	16	89.88	305471135
	17	94.62	305471136
	18	99.38	305471137
19	104.12	305471138	

